

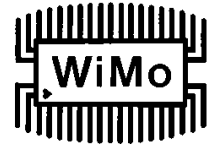

Aufsteckantenne 5 GHz SMA

Best.Nr. 18720.11



ELECTRICAL SPECIFICATIONS

ANTENNA TYPE :	RUBBER ANTENNA
MODEL NO.:	18720.11
REQUENCY RANGE:	5.1~5.5MHz
V.S.W.R:	<2.0
IMPEDANCE :	50 Ω ± 5 Ω
GAIN:	5dBi
WITH STANDING POWER:	MAX 5W
RADIATION:	OMNI
POLARIZATION:	VERTICAL
WEIGHT:	25g ± 2g
CONNECT TYPE:	SMA MALE
ELECTRICAL WAVE	1/2 λ
COLOR:	BLACK

WiMo Antennen und Elektronik GmbH

Am Gäxwald 14, D-76863 Herxheim Tel. (07276) 96680 FAX 6978

<http://www.wimo.com>

e-mail: info@wimo.com

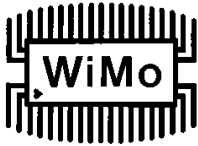

Aufsteckantenne 5 GHz SMA

Best.Nr. 18720.11



RETURN LOSS

S11 FORWARD REFLECTION
CHN1

TRANSMISSION/REFLECTION

LOG MAGNITUDE

REF=0.000 dB

10.000 dB/DIV

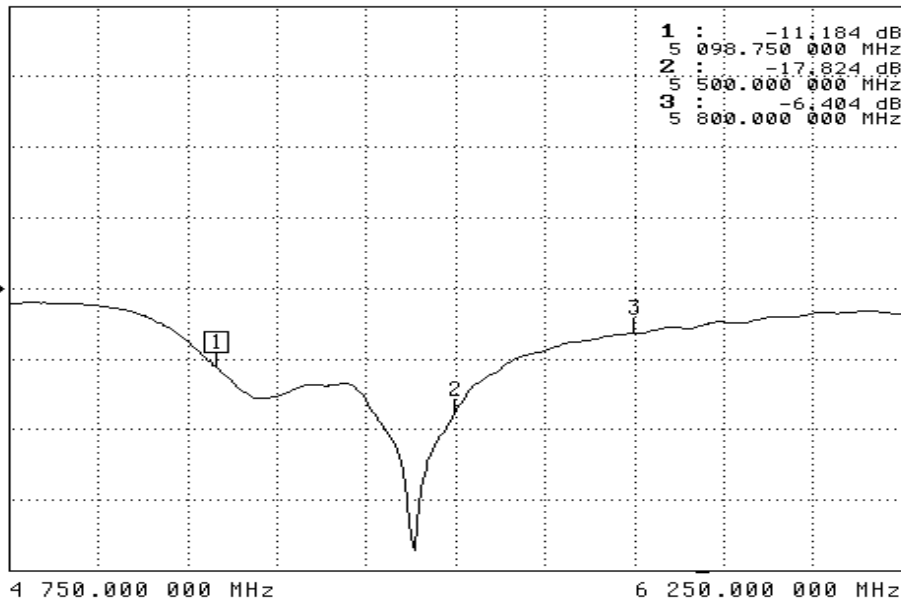

SWR

S11 FORWARD REFLECTION
CHN1

TRANSMISSION/REFLECTION

SWR

REF=10.000 U

10.000 U/DIV

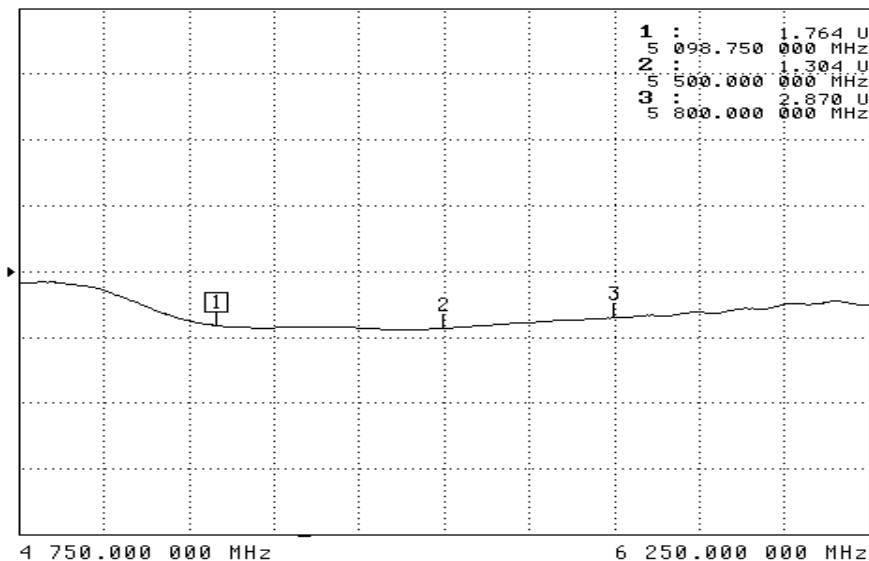

WiMo Antennen und Elektronik GmbH

Am Gäxwald 14, D-76863 Herxheim Tel. (07276) 96680 FAX 6978

<http://www.wimo.com>

e-mail: info@wimo.com



Aufsteckantenne 5 GHz SMA

Best.Nr. 18720.11

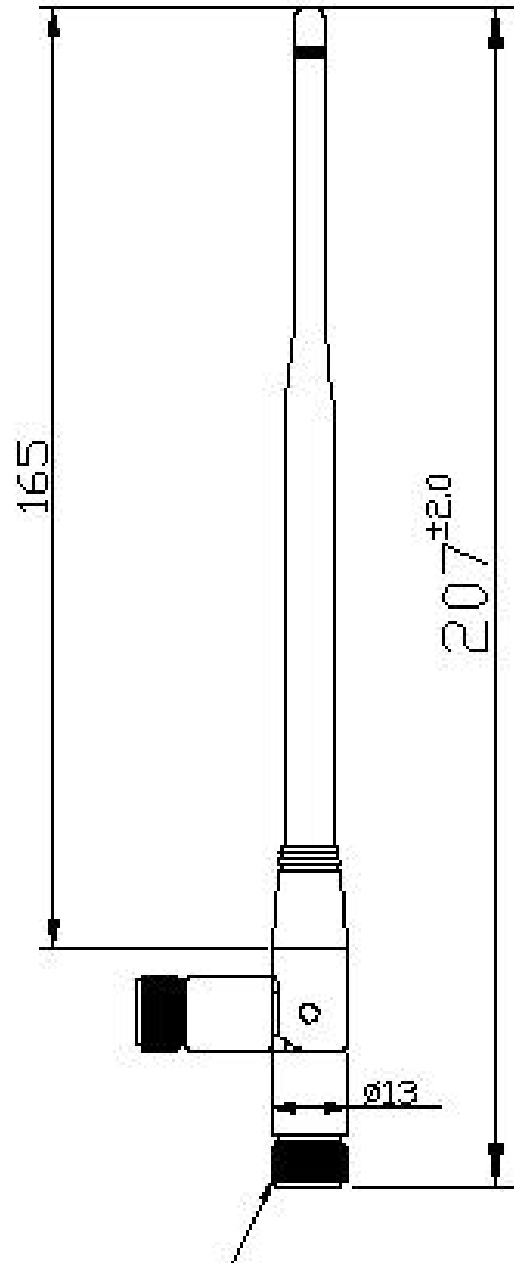
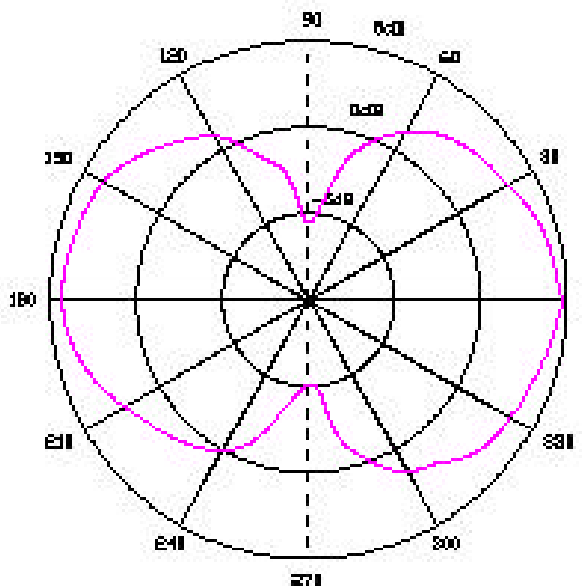
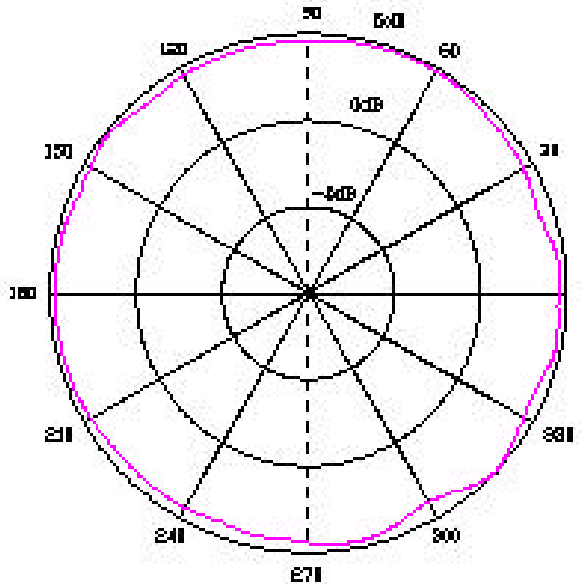
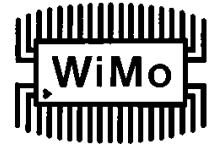

WiMo Antennen und Elektronik GmbH

Am Gäxwald 14, D-76863 Herxheim Tel. (07276) 96680 FAX 6978

<http://www.wimo.com>

e-mail: info@wimo.com